

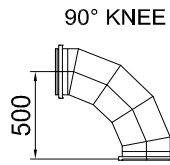

# 1000t BALLAST SYSTEM

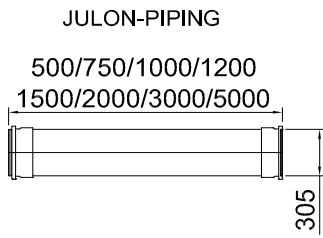

**HYDRAULIC PUMP**  
 VOLVO F12-60  
 Weight : 120kg  
 Maximum speed: 1000-1800rpm  
 Input capacity : 50kW  
 Maximum. flow : 1400m<sup>3</sup>/h

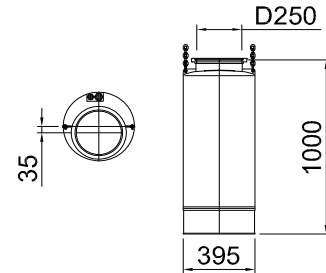

**PUMP-TROLLEY**

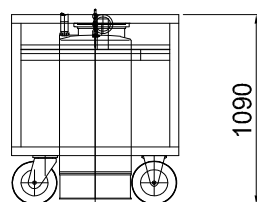
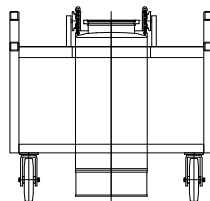
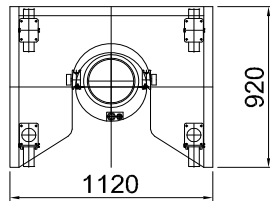

**BALLAST-PUMP FRAME'S**

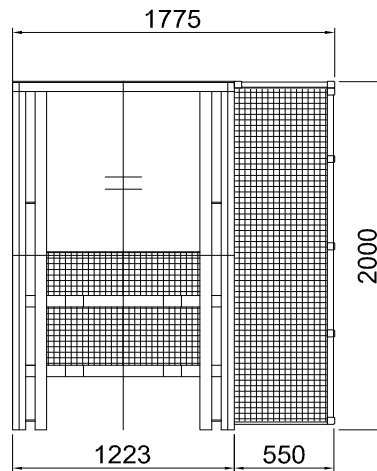
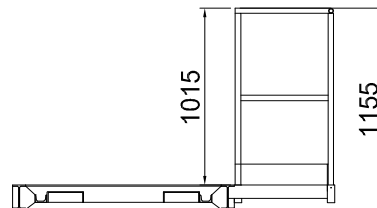

**POWER PACK**  
 Deutz BF6M1013  
 Weight : 4000kg  
 Speed : 2300rpm  
 Max. capacity 119kW

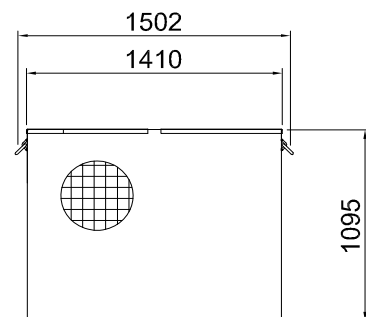
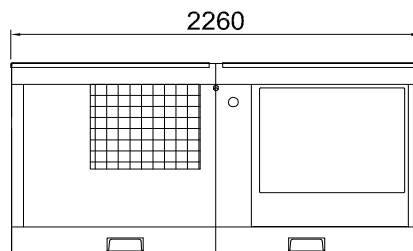

# 500t BALLAST SYSTEM

## JULON-PIPING

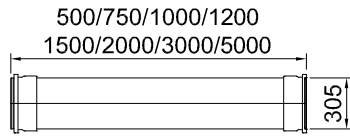

## 90° KNEE

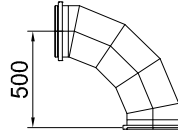

## 45° KNEE

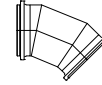

## POWER PACK

3xVOLVO F1-20

Weight : 2300kg

Max. Pressure : 300bar

Max. capacity : 132ltr/min

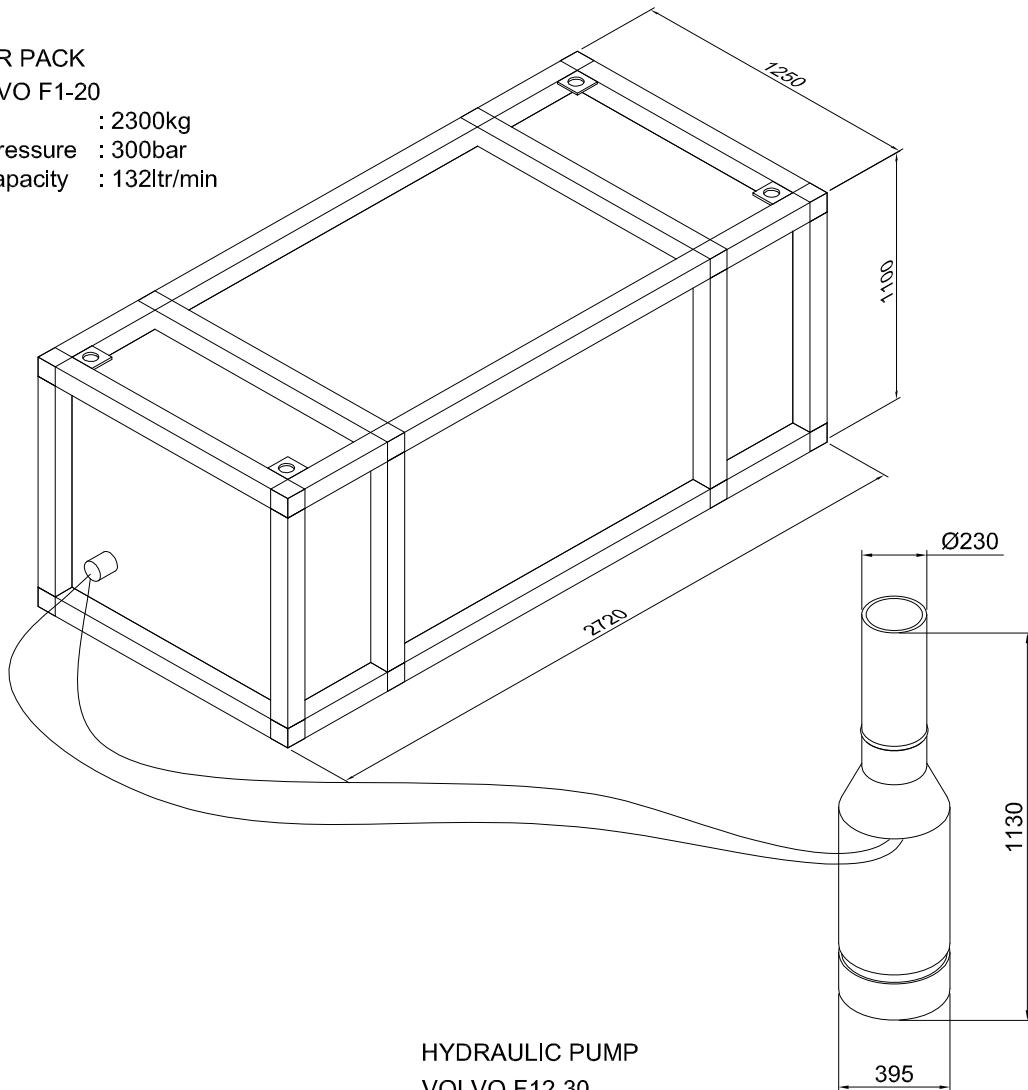

## HYDRAULIC PUMP

VOLVO F12-30

Weight : 85kg

Maximum speed : 1700rpm

Input capacity : 28kW

Maximum. flow : 500m<sup>3</sup>/h